

High-Side Measurement Current-Shunt Monitor Evaluation Board

General Description

This document explains the function and use of the RTQ6052 evaluation board (EVB), and provides information to enable operation, modification of the evaluation board and circuit to suit individual requirements.

Table of Contents

General Description	1
Performance Specification Summary	2
Power-up & Measurement Procedure	2
Detailed Description of Hardware	3
Bill of Materials.....	4
Typical Applications	5
Evaluation Board Layout.....	7
More Information.....	8
Important Notice for Richtek Evaluation Board.....	8

Performance Specification Summary

Summary of the RTQ6052GF Evaluation Board performance specification is provided in Table 1. The ambient temperature is 25°C.

Table 1. RTQ6052GF Evaluation Board Performance Specification Summary

Specification	Test Conditions	Min	Typ	Max	Unit
Default Input Voltage	Default = 12V	2	--	80	V
Supply Voltage	Default = 12V	2.9	--	18	V
Sensing Current		--	0.5	--	A
Output Voltage		--	5	--	V
Gain		--	100	--	V/V
Quiescent Current	V _{OUT} = 2V, T _A = -40°C to 125°C	--	--	1200	μA

Power-up & Measurement Procedure

Suggestion Required Equipments

- DC Power Supply (Chroma, 62006P-100-25)
- Electronic load capable of 6A
- Function Generator
- DC Meter
- Oscilloscope

Quick Start Procedures

1. Connect a short line from GND (golden pin) to GND (test pin).
2. Apply VCC = 12V input power supply (2.9V < VCC < 18V) to VCC and GND terminals.
3. Apply VIN+ = 12V input power supply (2V < VIN+ < 80V) to VIN+ and GND terminals.
4. The default sense resistance is 100mΩ.
5. Connect an external load to VIN- and GND terminals, and keep loading current = 0.5A.
6. Measure the sense voltage (approximately 50mV) between VIN+ and VIN-.
7. Measure the output voltage (approximately 5V) between VOUT and GND.

Detailed Description of Hardware

Headers Description and Placement

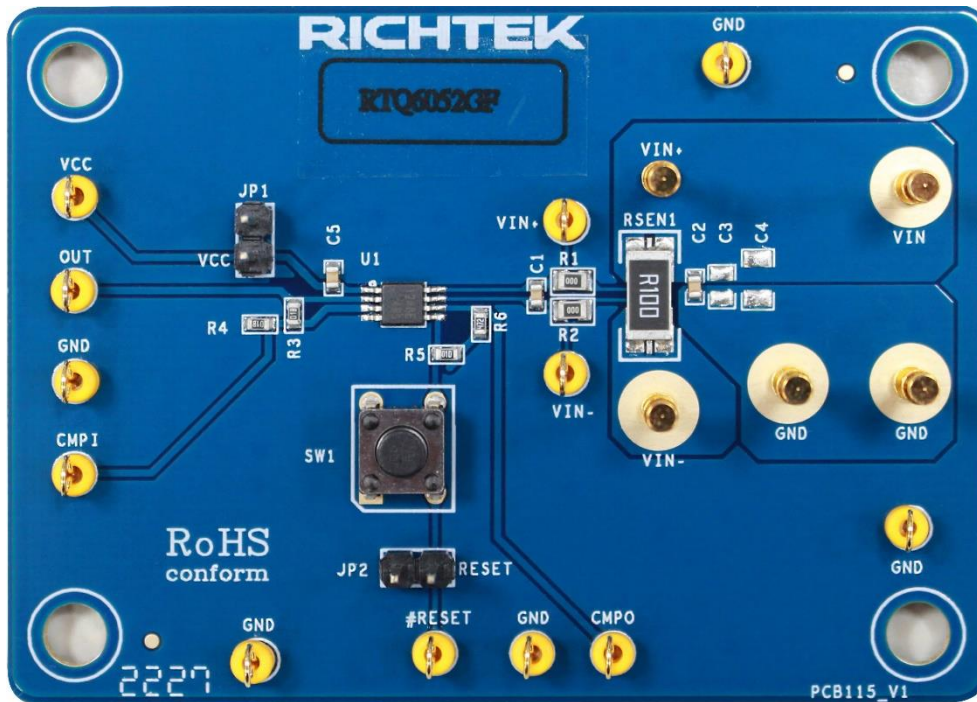

Carefully inspect all the components used in the EVB according to the following Bill of Materials table, and then make sure all the components are undamaged and correctly installed. If there is any missing or damaged component, which may occur during transportation, please contact our distributors or e-mail us at evb_service@richtek.com.

Test Points

The EVB is provided with the test points and pin names listed in the table below.

Test point	Function
VCC	Power input test point.
OUT	Output Voltage test point.
CMP1	Comparator input test point.
GND	Ground.
#RESET	Reset input pin.
CMPO	Open-drain comparator output.
VIN-	Negative current-sensing input.
VIN+	Positive current-sensing input.
JP1	VCC to ground test point.
JP2	RESET jumper. Connect RESET to ground or pull high to VCC.
SW1	RESET control switch. Connect RESET to ground or pull high to VCC.

Bill of Materials

Reference	Count	Part Number	Value	Description	Package	Manufacturer
C1, C2, C5	3	GRM188R71H104KA93D	0.1 μ F/25V/X7R/0603	Capacitor, Ceramic	0603	MURATA
R1, R2	2	RTT05000JTP	0/0805	Resistor	0805	RALEC
R3, R4	2	RTT031001FTP	1k/0603	Resistor	0603	RALEC
R5	1	WR06X1003FTL	100k/0603	Resistor	0603	WALSIN
R6	1	RTT034701FTP	4.7k/0603	Resistor	0603	RALEC
RSEN1	1	RTT25R100FTE	0.1	Resistor	2512	RALEC
U1	1	RTQ6052GF	RTQ6052GF	CSOP	MSOP-8	RICHTEK

Typical Applications

EVB Schematic Diagram

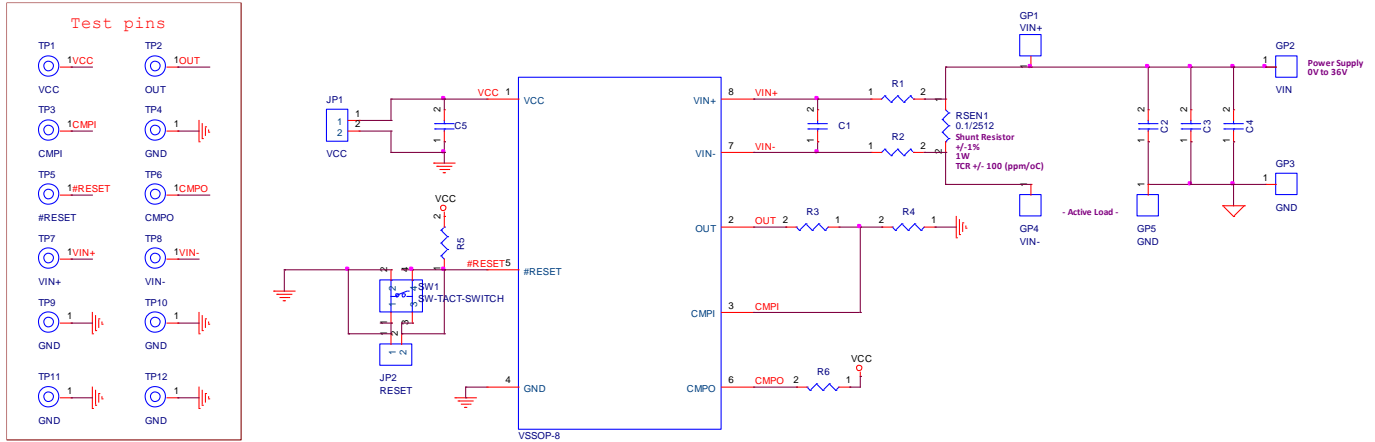

Note:

1. Do not hot-plug input voltage and supply voltage on the board. If hot-plugging is required, add ~100 μ F electrolytic capacitor at the input.
2. All the stated input and output capacitor values are the effective capacitances, including any de-rating effect, like a DC Bias. The stability of the converter may be impacted when using small size MLCC output capacitors, which may have much lower capacitance at the application DC output voltage than the rated value.

Measurement Results

Gain Error with Power Supply Measurement

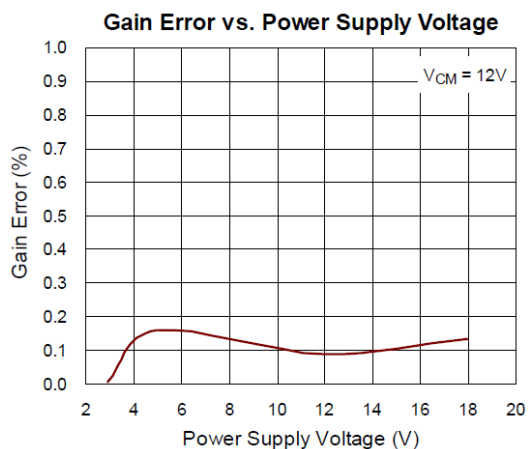

Gain Error with Temperature Measurement

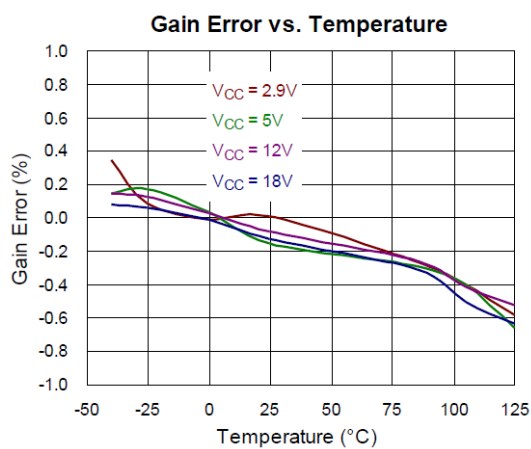

Offset Voltage with Temperature Measurement

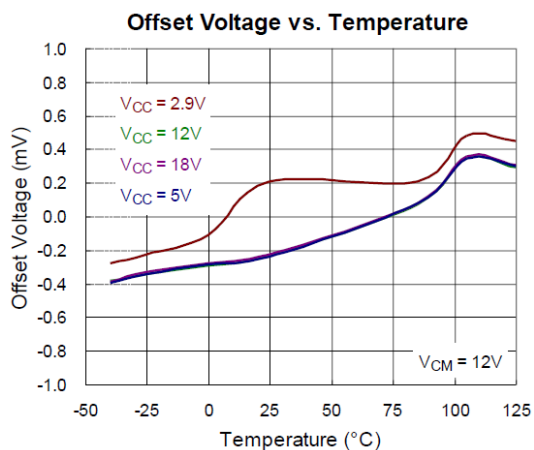

Output Error with Common-Mode Measurement

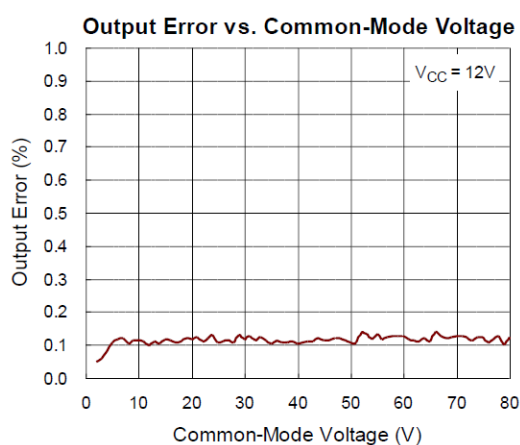

#RESET signal = Low, CMPO is dominated by CMPI and 0.6V

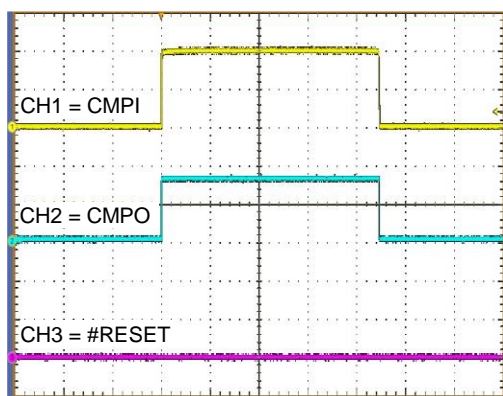

Output Voltage vs. Sense Voltage

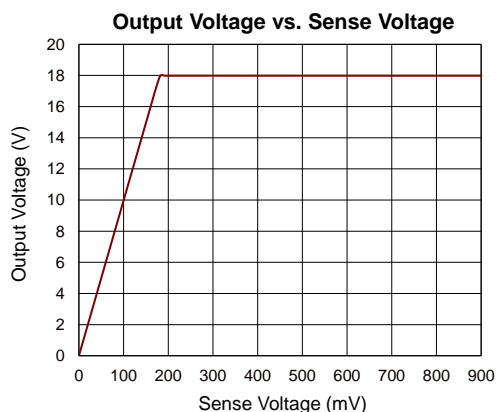

Evaluation Board Layout

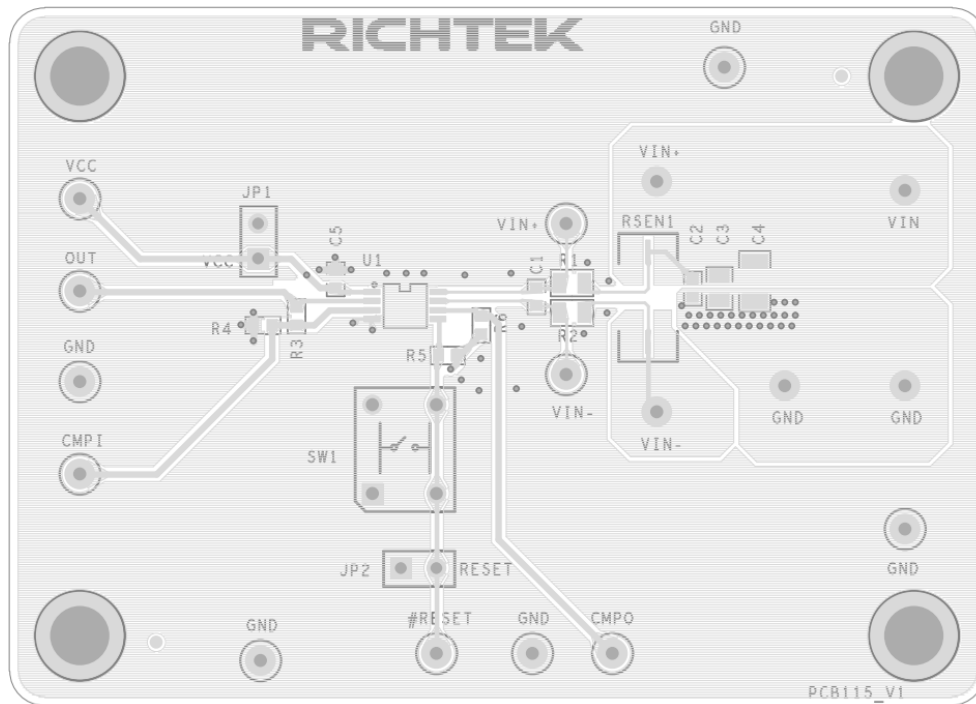

Figure 1. Top View

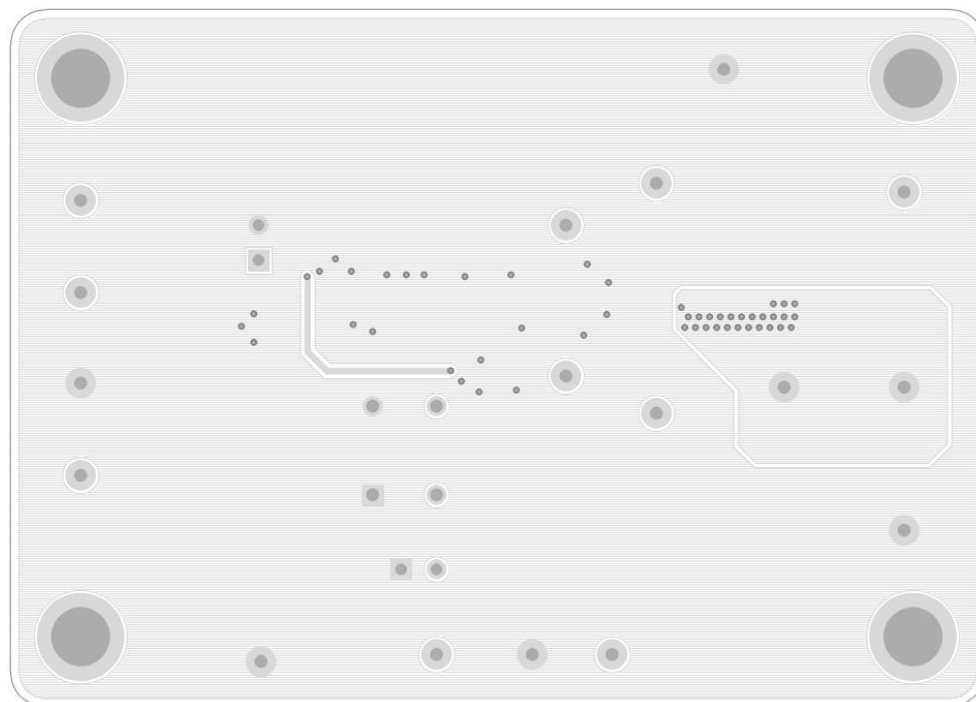

Figure 2. Bottom View

More Information

For more information, please find the related datasheet or application notes from Richtek website <http://www.richtek.com>.

Important Notice for Richtek Evaluation Board

THIS DOCUMENT IS FOR REFERENCE ONLY, NOTHING CONTAINED IN THIS DOCUMENT SHALL BE CONSTRUED AS RICHTEK'S WARRANTY, EXPRESS OR IMPLIED, UNDER CONTRACT, TORT OR STATUTORY, WITH RESPECT TO THE PRESENTATION HEREIN. IN NO EVENT SHALL RICHTEK BE LIABLE TO BUYER OR USER FOR ANY AND ALL DAMAGES INCLUDING WITHOUT LIMITATION TO DIRECT, INDIRECT, SPECIAL, PUNITIVE OR CONSEQUENTIAL DAMAGES.